

www.silverson.com

high shear mixers

the first name in high shear mixers



better mixers, better results



The Silverson way

For over 60 years Silverson has specialized in the manufacture of quality high shear mixers for processing and manufacturing industries worldwide.

With customers in over 150 countries, and serving industries as diverse as food, pharmaceuticals, cosmetics, lubeoils and petrochemicals, Silverson has become the world leader in the field of high shear mixing. Time after time, companies specify Silverson mixers as the "standard" equipment for their manufacturing process.

The key to this success is based on the professionalism and commitment Silverson shows to each of its customer's needs. Whether supplying machines from its standard range of mixers or designing equipment specifically to meet an individual customer's requirements, quality is guaranteed.

With a customer base that includes many of the world's largest companies, Silverson is constantly at the forefront of new technologies. Developing and applying new high shear mixing techniques to meet these needs, Silverson has the experience, knowledge and commitment to both quality and service to solve today's mixing needs and those of the future.

A truly international company, Silverson is represented by a network of associated companies, distributors and agents in over 50 countries, serving North America, Europe, Asia, Australasia, South America and Africa.



The Silverson advantage

Speed

The exceptionally rapid Silverson mixing action substantially reduces process times compared with conventional agitators and mixers, and can reduce mixing times by up to 90%.

Versatility

The advantage of the Silverson approach to mixing is that any one machine can perform the duties that in the past may have required several different pieces of process equipment. This unrivalled versatility allows any machine to perform the widest range of mixing applications:

Blending

A homogeneous product is rapidly produced when blending liquids of similar or greatly varying viscosities, eliminating problems such as stratification.

Emulsifying and homogenizing

Emulsions (typically in the range of 0.5 to 5 microns) can be easily achieved.

Disintegration

All Silverson rotor/stator mixers can disintegrate matter of animal, vegetable, mineral or synthetic origin in a single operation.

Particle size reduction

Uniformly mill both solid and semi-solid materials into either solution or fine suspension.

Gelling and solubilizing

The high shear action of the Silverson rotor/stator can rapidly disperse gums, alginates, C.M.C., carbopols, etc., resulting in an agglomerate-free solution within minutes.

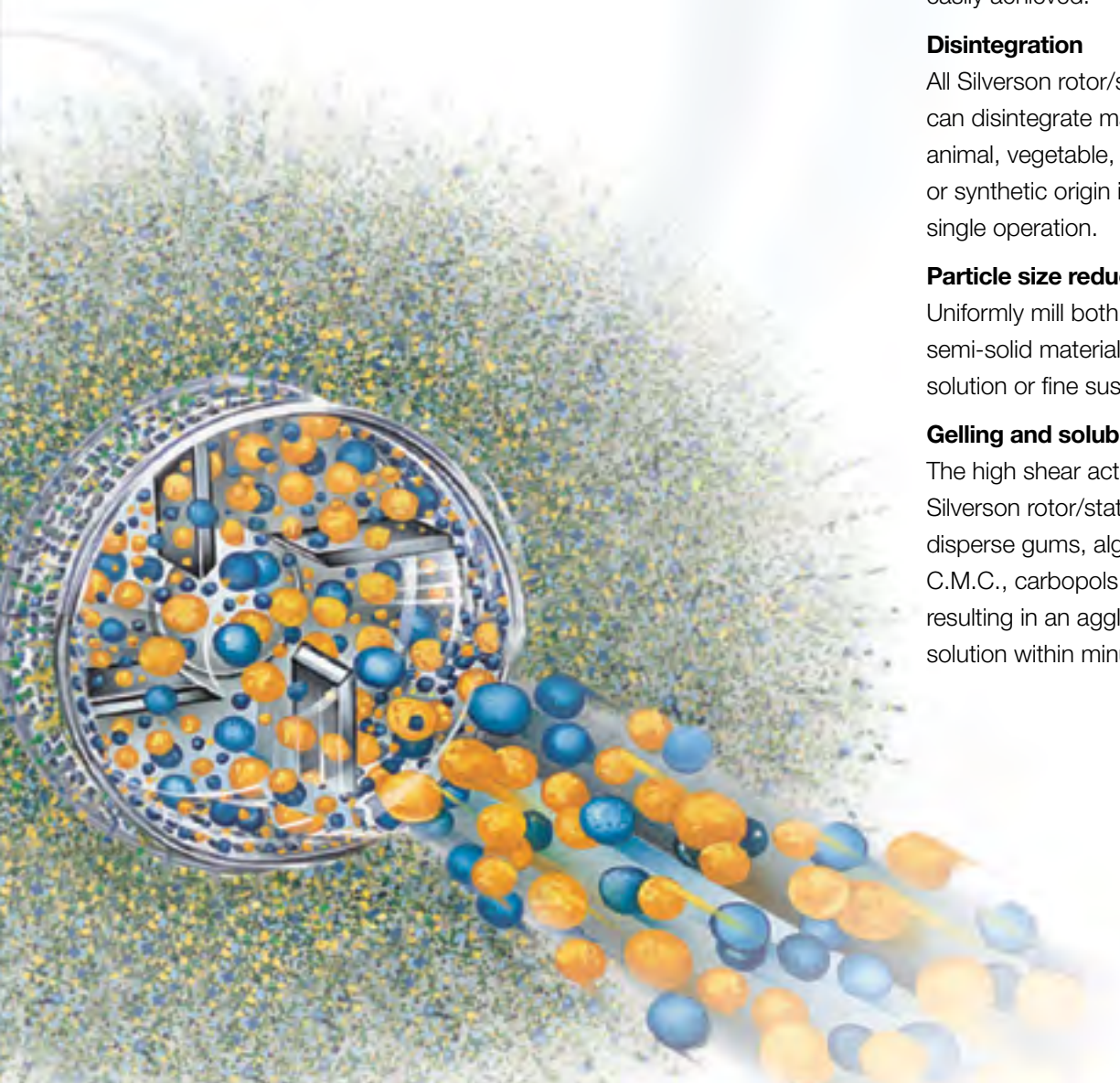

How the Silverson works

The advantages of Silverson's high shear rotor/stator mixer over simple conventional stirrers or agitators stem from the multistage mixing/shearing action as materials are drawn through the specially designed Silverson workhead - the heart of every machine.

Stage 1

The high-speed rotation of the rotor blades within the precision machined mixing workhead exerts a powerful suction, drawing liquid and solid materials upwards from the bottom of the vessel and into the center of the workhead.

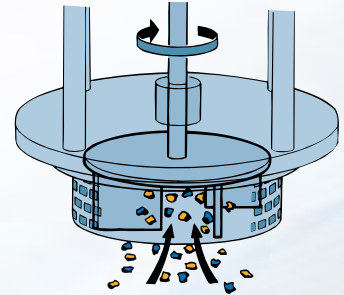

Stage 2

Centrifugal force then drives materials towards the periphery of the workhead where they are subjected to a milling action in the precision machined clearance between the ends of the rotor blades and the inner wall of the stator.

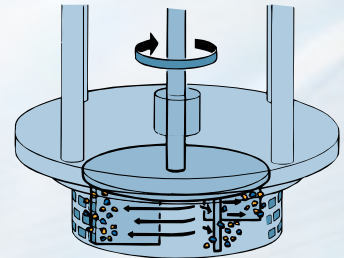

Stage 3

This is followed by intense hydraulic shear as the materials are forced, at high velocity, out through the perforations in the stator and circulated into the main body of the mix.

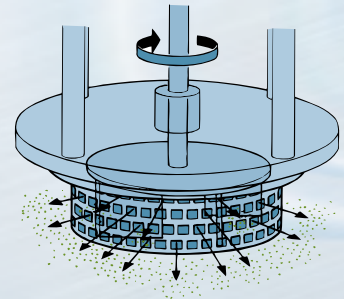

Stage 4

The materials expelled from the head are projected radially at high speed towards the sides of the mixing vessel. At the same time, fresh material is continually drawn into the workhead maintaining the mixing cycle. The effect of the horizontal (radial) expulsion and suction into the head is to set up a circulation pattern that minimizes aeration caused by the disturbance of the liquid's surface.

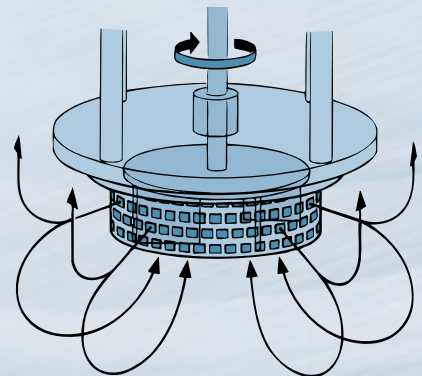

Interchangeable heads and screens

A comprehensive range of workheads and screens is available for all Silverson rotor/stator mixers. These easily interchangeable workheads offer great versatility by allowing any machine to be adapted to perform a wide range of mixing operations including emulsifying, homogenizing, disintegrating, dissolving, dispersing, blending, particle size reduction and de-agglomerating. Changing from one head or screen to another is quick and simple.

General purpose disintegrating head

This is the most versatile of all the heads, giving an exceptionally vigorous mixing action. Ideal for general mixing applications, its uses also include the disintegration of solids and the preparation of gels and thickeners, suspensions, solutions and slurries.



Slotted disintegrating head

For the disintegration of fibrous materials, such as animal and vegetable tissue, as well as the disintegration and solubilization of “elastic” materials such as rubbers and polymers.



Square hole high shear screen™

Provides exceptionally high shear rates ideal for the rapid size reduction of soluble and insoluble granular solids. It is also suitable for the preparation of emulsions and fine colloidal suspensions.



Standard emulsor head and emulsor screen

Suitable for liquid/liquid preparations and especially useful for all emulsions. Emulsor screens are available in fine, medium or coarse perforations.



Silverson service

Experience and know how

Silverson has been the leader in High Shear Mixing technology for over 60 years and has built up a detailed knowledge of mixing process requirements. This accumulated knowledge enables our technical staff and sales representatives to clearly identify a client's needs and recommend the type of mixer most suited to provide an efficient and economical solution.

Extensive test facilities

Available for the use of all clients, Silverson operates dedicated test facilities equipped with a wide range of laboratory and production scale machines where customers may test new products and discuss their applications with our technical staff. If preferred, Silverson mixers can be provided for on-site trials to allow evaluation under actual production conditions.

Customization

Increasingly today's process manufacturers require equipment to be designed to meet their own particular needs. Silverson has a positive approach and flexibility, which allows mixers to be custom designed and built to suit individual users' specific requirements.

Worldwide support

A truly international company, Silverson is represented by a network of associated companies, distributors and agents in over 50 countries, serving Europe, North America, Asia, Australasia, South America and Africa.

Installation

Silverson offers expert advice and, if required, can assist with and supervise installation and start up.

After-sales service

With over 60 years of experience Silverson realizes the importance their customers place on reliable and rapid back-up service. Our large stock of manufactured parts enables us to dispatch most standard spares the same day they are ordered.



Some of Silverson's clients

Silverson is pleased to be able to service the exacting needs of some of the finest companies in the world.



These trademarks & company logos are included with the kind permission of the owners.

Laboratory scale mixers

Silverson Laboratory mixers are suitable for the widest range of applications - mixing, emulsifying, homogenizing, disintegrating, dissolving - with an efficiency and flexibility unmatched by other machines. With a capacity from 1ml up to 12 liters and the ability to mix in-line with flow rates up to 20 liters/minute, they offer excellent reproducibility when scaling up and provide an accurate and easy means of forecasting the performance of larger Silverson machines under full-scale working conditions.

The Silverson L5 Series is the latest development in High Shear Laboratory mixing, ideal for all routine laboratory work, research and development, QA analysis and small scale production in all industries.

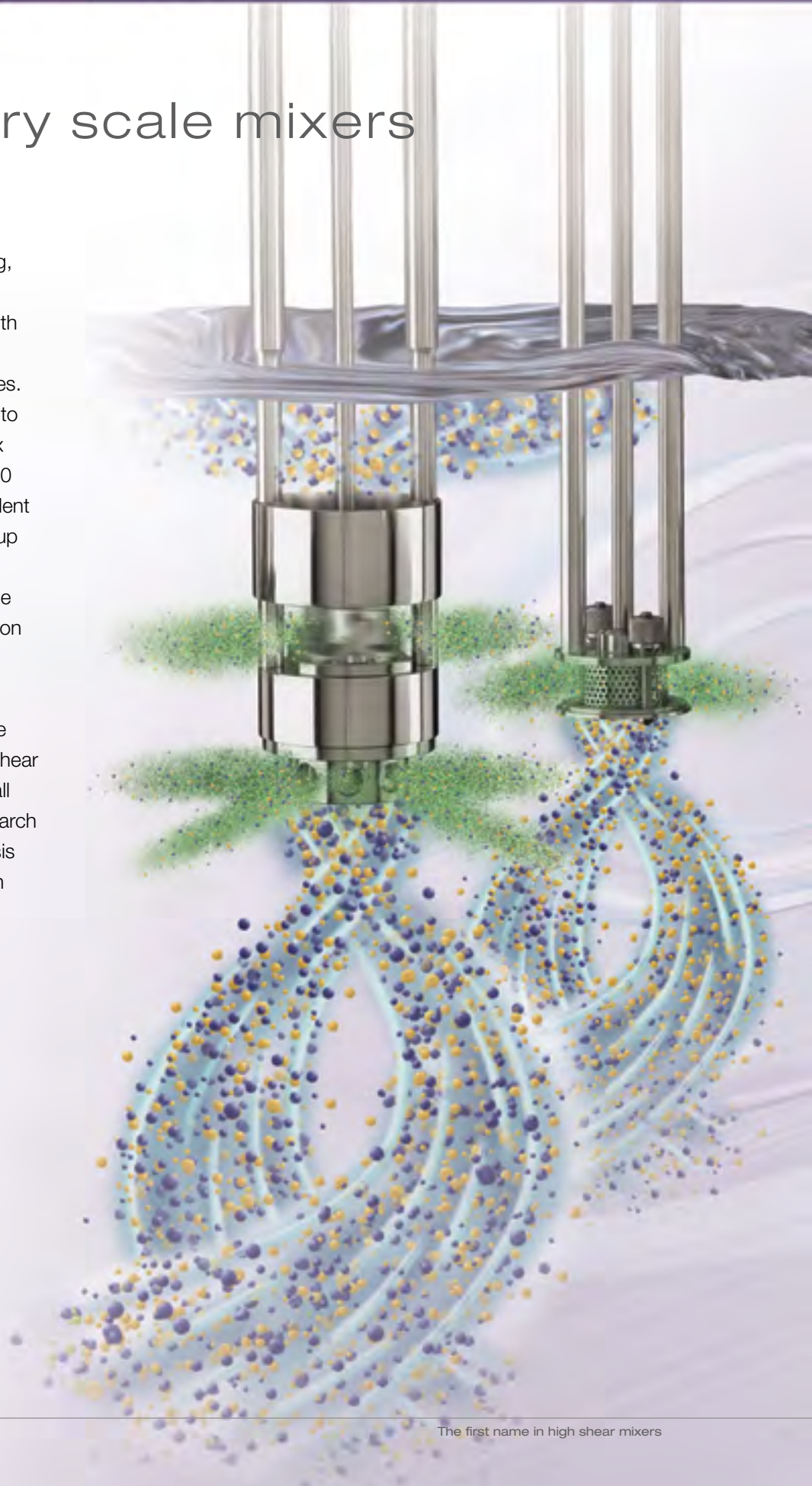

L5M-A mixer

L5M-A Mixer

The multifunctional L5M-A Model features touch pad control with digital tachometer, programmable integral timer and amperage display, all accessed via the Mode button. The unit can be supplied with a "DataLogger" program allowing monitoring of speed and power draw over time. This level of instrumentation is invaluable for applications where process validation and reproducibility are required.

Motor unit

Powerful 1hp (750W) 110 volt, single phase (220 volt optional), 50/60 Hz. Nominal maximum speed 8000 rpm (6000 rpm under full load).

Speed control

Infinitely variable electronic speed control with integral on/off switch.

Electric rise & fall bench stand

The mixing unit may be effortlessly raised and lowered using the touch pad controls on the motor unit.

Construction

All wetted parts are in grade 316L stainless steel with the exception of the bushing, which may be bronze alloy or PTFE.

The L5 is finished in a tough, easy-to-clean, non-chip white nylon coating. The flat base is covered by a removable non-slip solvent-resistant mat.

Interchangeable mixing assemblies

Standard assembly (two arm) supplied complete with a General Purpose Disintegrating Head, Square Hole High Shear Screen, Standard Emulsor Screen and Axial Flow Head.

Slotted Disintegrating Heads, Fine Emulsor Screen, Pump Heads and other special heads are available as optional extras, see overleaf.

Capacity - depending on viscosity - up to 12 liters. Mixing unit dimensions – length 11 1/2" (290mm), width 2 1/4" (57mm).



Mixing assemblies

Duplex assembly

The Duplex comprises two workheads facing in opposite directions. The upper head pulls materials down from the surface of the mix, and provides a coarse disintegrating action, while the lower head draws material up from the base of the mixing container, further reducing particle size to accelerate solubilization or suspension.

This combined use of two workheads makes the Duplex ideal for high viscosity mixes and applications where light or buoyant material (powders, rubbers and polymers, etc.) needs to be drawn down from the surface of a mix and rapidly dispersed.

Typical applications

- Rapid solution of rubbers and polymers for the production of luboils, adhesives and asphalt compounds
- Disintegration and dissolving solid resin for varnishes
- Vegetable and meat purée/slurries

Tubular mixing assemblies

A series of interchangeable tubular mixing units suitable for use in narrow-necked containers is available, with capacities from 1 - 500ml.

1" tubular

Capacity, depending on viscosity, 50ml up to 500ml.

3/4" tubular

Capacity, depending on viscosity, 20ml up to 250ml.

5/8" micro

Capacity, depending on viscosity, 5ml up to 50ml.

3/8" mini-micro

Capacity, depending on viscosity, 1ml up to 10ml.

Ultramix

The Silverson Ultramix is designed for applications which are beyond the capabilities of a conventional agitator or stirrer but do not necessarily require the intense high shear of a Silverson rotor/stator mixer.





In-Line mixing assembly

The In-Line assembly fits on to the model L5 Series Laboratory range and converts it into an in-line mixer/homogenizer.

The centrifugal action of the rotor in the high shear rotor/stator workhead generates a non-positive pumping action, which gives a throughput on low

viscosity liquids of approximately 20 liters/minute, reducing as the viscosity increases.

The In-Line assembly is suitable for use at atmospheric pressure only. It is not recommended for use on abrasive, corrosive or flammable materials.

Specialized mixers

L5 Sealed unit laboratory mixer

Designed for research in the pharmaceutical and biotechnology fields, the L5 Sealed Unit allows sterile or highly infected tissues to be handled under conditions of absolute safety.

The Sealed Unit features a Quick-Release mechanism permitting use with a wide range of mixing assemblies.

Mixing vessels

Glass vessels with capacities from 7ml up to 1 liter are available. Stainless steel vessels are available with volumes from 1 - 10 liters.

Operation under vacuum

Special sealed mixing assemblies are available for operation under vacuum.

Model L2/Air (Compressed air)

Suitable for use in Explosion Hazard areas. The L2/Air is powered by a 0.25 hp, 6000 rpm variable speed air motor. The L2/Air will accept all L5 Series mixing assemblies. Supplied with a manually operated adjustable bench stand.

Pilot scale mixers

AX series

This series of mixers is designed for small-scale production in pilot plants, research institutes, hospital pharmacies, etc. Light and easily operated, AX series models have a capacity of up to 50 liters.



Model AX5

The AX5 features touch pad controls and is compatible with Silverson's "DataLogger" system.

Motor

Powerful 1 hp (0.75 kW) 110 volt single phase motor (220 volt optional) 50/60 Hz.

Speed control

Infinitely variable speed control. Nominal maximum speed 6000 rpm.

Electric Rise & Fall Stand

The unit features an integral rise and fall stand with touch pad controls.

Model AX60

The Model AX60 features a fixed speed 1 hp 3 phase motor. TEFC, washdown duty and explosion proof motors are available. Variable speed available via an inverter as an optional extra.

More powerful motors allowing a maximum speed of up to 6000 rpm also available.

Model AX/Air

The Model AX/Air is powered by an intrinsically safe compressed air motor suitable for use in Explosion Hazard areas.

Bench stand

Spring assisted or electric rise and fall bench stands are available for use with the AX60 and AX/Air models.

Verso - pilot scale In-Line mixer

The Silverson Verso is a bench top In-Line mixer ideal for laboratory or pilot scale applications. The unit offers excellent reproducibility when scaling up and provides an accurate and easy means of forecasting the performance of larger In-Line mixers under full-scale working conditions.

The Verso is equipped with a digital tachometer, ammeter and programmable timer, invaluable for applications where process validation and reproducibility are required. It is also compatible with the Silverson "DataLogger" program.

Features

- Touch pad control panel.
- Powerful 1 hp (0.75 kW) motor with infinitely variable speed control.
- Single or multistage interchangeable workheads available.
- Self-pumping.
- Maximum operating pressure 100 psi (7.6 bar).
- 0.75" Tri-clamp inlet/outlet connections.
- Single mechanical shaft seal.
- All wetted parts are in grade 316L stainless steel.
- Sanitary construction.

Advantages

- Eliminates agglomerates and fish eyes.
- Creates stable emulsions and suspensions.
- Reduces particle size.
- Rapidly dissolves solids.
- Accelerates reactions.
- Aeration free.
- No bypassing.



Batch mixers

Silverson offers a complete range of multipurpose batch mixers. The machines are able to perform the widest variety of applications - mixing, emulsifying, homogenizing, disintegrating, dissolving - with an efficiency and flexibility unmatched by other machines. Capacities from 1 to 8,000 gallons.

The Silverson range of High Shear Batch mixers are of robust and simple construction, which ensures that cleaning and maintenance is kept to an absolute minimum. The range can be divided into two distinct categories – medium range and large range models.

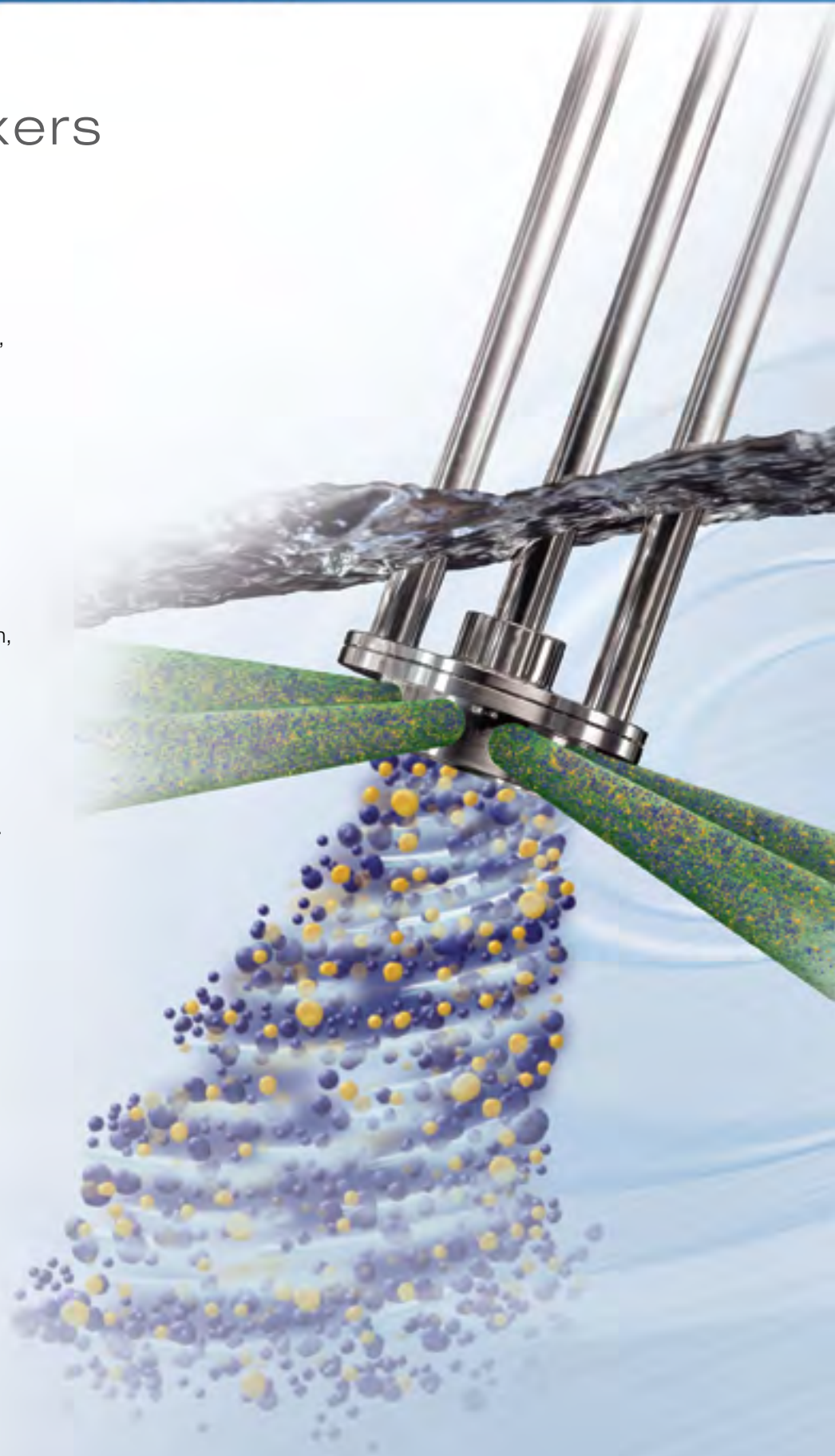

Medium range – Models BX to GX25

Each machine employs the special “interchangeable” Silverson rotor/stator mixing head, which allows it to be used on a wide variety of different products.

Any machine in this range from the 1.5 hp BX60 to the 25 hp GX25 can be used on a mobile hydraulic floor stand (local safety regulations permitting). This option greatly increases the flexibility of these mixers, allowing them to be moved from vessel to vessel and to be raised and lowered during operation, if required, in order to give the optimum mixing position at varying stages of the process.



Large range – Models 700X to MX



Silverson is the world leader in the specialized design and manufacture of large scale rotor/stator mixers with a capacity of up to 8,000 gallons. All these machines are individually built to order and constructed specifically to suit each customer's requirements.

The large scale mixers possess all the qualities and flexibility of Silverson's medium range models and include a number of additional and unique features.

Each mixer is designed and built to the highest possible engineering standards. From the specially balanced motors to the fitting of precision ground shafts, which are finish turned in-house to ensure critical vibration free running, no aspect of manufacture escapes our rigorous inspection.

These machines are designed to be maintained and serviced in place wherever possible. Quick release shaft couplings, split two-part downthrust propeller and hard-surfaced sacrificial shaft journal sleeves are just a few of the features designed to keep maintenance and downtime to a minimum.

Silverson prides itself on a technical staff that caters to the precise needs of each customer.

Technical specifications

Materials of construction

All wetted parts in 316L stainless steel. Special materials on request.

Bushing material

The bushing will normally be bronze alloy or reinforced PTFE depending on the application.

Motors

TEFC, washdown duty and explosion proof motors are available as standard. Inverter rated, stainless steel and other motors are available as optional extras.

Mounting

Models BX up to GX can be mounted on mobile hydraulic floor stands. Alternatively they can be supplied with either a rectangular or circular flange for mounting on the vessel. Tri-clamp mounting is also available. Larger machines (Model 700X and above) require vessel mounting.

Sealing

All Silverson Batch mixers are designed for operation in open vessels. Single and double mechanical shaft sealing for operation under vacuum and/or positive pressure is available for most machines.

Cleaning

The machines are in most cases self-cleaning, a short run between successive operations in water, detergent or an appropriate solvent being all that is necessary. For more thorough cleaning, dismantling is easy and downtime minimal.



General purpose disintegrating head



Slotted disintegrating head



Square hole high shear screen™

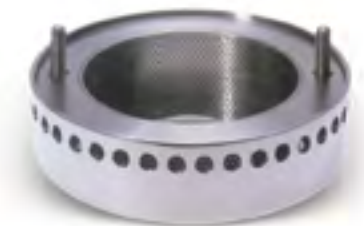

Standard emulsor head and emulsor screen

Duplex disintegrator dissolver

The Duplex was specifically developed for the disintegration and solubilization of solid rubbers and polymers for the lubeoil and adhesive industries, but its success has now seen its introduction into all fields of mixing, whether chemical, pharmaceutical or food.

The Duplex differs from the standard multipurpose batch mixers in having two workheads facing in opposite directions; the upper head pulls material down from the surface of the mix, while the lower head draws material up from the base of the vessel.

The combined use of two workheads makes the Duplex ideal for applications where light or buoyant material (powders, rubbers and polymers, etc.) needs to be drawn down from the surface of a mix and rapidly dispersed. Because of the added movement afforded by the two workheads, the Duplex is also ideal for use on high viscosity materials.

Typical applications

- Rapid solution of rubbers and polymers into lubricating oils, solvents and bitumen for the production of lubeoils, adhesives and bituminous compounds
- Disintegration and dissolving of solid resin for the production of varnish
- Vegetable and meat purée/slurries
- Recovery of waste confectionery

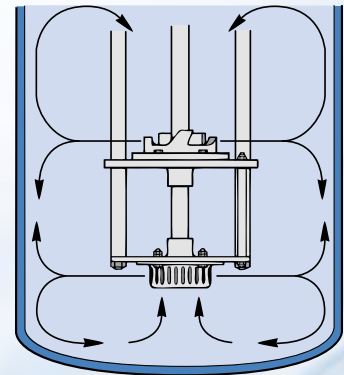

Specialized mixers

Abramix RBX

No immersed bearing

With the standard Silverson mixer a highly abrasive product can cause excessive wear on the bush and the shaft. In the Abramix RBX, the bush has been completely eliminated by the use of a heavy-duty shaft, which is firmly supported by two precision roller bearings, situated above the level of the product being mixed. Minimum maintenance is a key feature of the design.

Dry running

Dry running in non-flammable products is possible, allowing mixing to continue uninterrupted while emptying the mixing vessel.

Typical applications

- Liquid Glazes: Preparation and redispersion including incorporation of Pigments, Wetting Agents, Hardeners, etc.
- Ceramic slips - Clays and Silicas - Texture Paints
- Foundry Compounds

Tubular mixers

Silverson tubular mixers are designed for operation in sealed vessels where a product-lubricated mechanical shaft seal is required.

Tubular mixers are suitable for operation under atmospheric or positive pressures and are ideal for mixing products where sealant fluids need to be avoided.

The mixer shaft is sealed at its lower end by a conventional mechanical shaft seal, which is lubricated and cooled by the product being mixed.

As with all Silverson rotor/stator mixers, interchangeable stators are available to adapt the machine for varying processes.

The tubular design also allows the machine to fit through relatively small diameter vessel openings.

Each mixer is designed to suit individual process requirements.

Typical applications

- Active ingredients into inhalants
- Injectables
- Vaccines



Ultramix

The Silverson Ultramix is designed for applications, which are beyond the capabilities of a conventional agitator or stirrer, but do not necessarily require the intense high shear of a Silverson rotor/stator mixer.

The advantages

- Ultra sanitary design
 - single-shaft, single-piece mixing head.
 - the Ultramix series is designed for Clean-In-Place (CIP) with Sterilize-In-Place (SIP) as an option.
- Full compliance with 3A, USDA and cGMP requirements.
- Excellent in-tank movement is provided by the dynamic mixing head, even when processing high viscosity mixes.
- The powerful vortex can rapidly incorporate large volumes of powders.
- Low maintenance - the single-piece mixing head is of a simple, robust construction with no wearing parts or bushings.
- Reduced power requirement compared with conventional high shear mixers.
- The design is suitable for applications from aggressive chemical service to the most demanding sanitary standards and requirements.

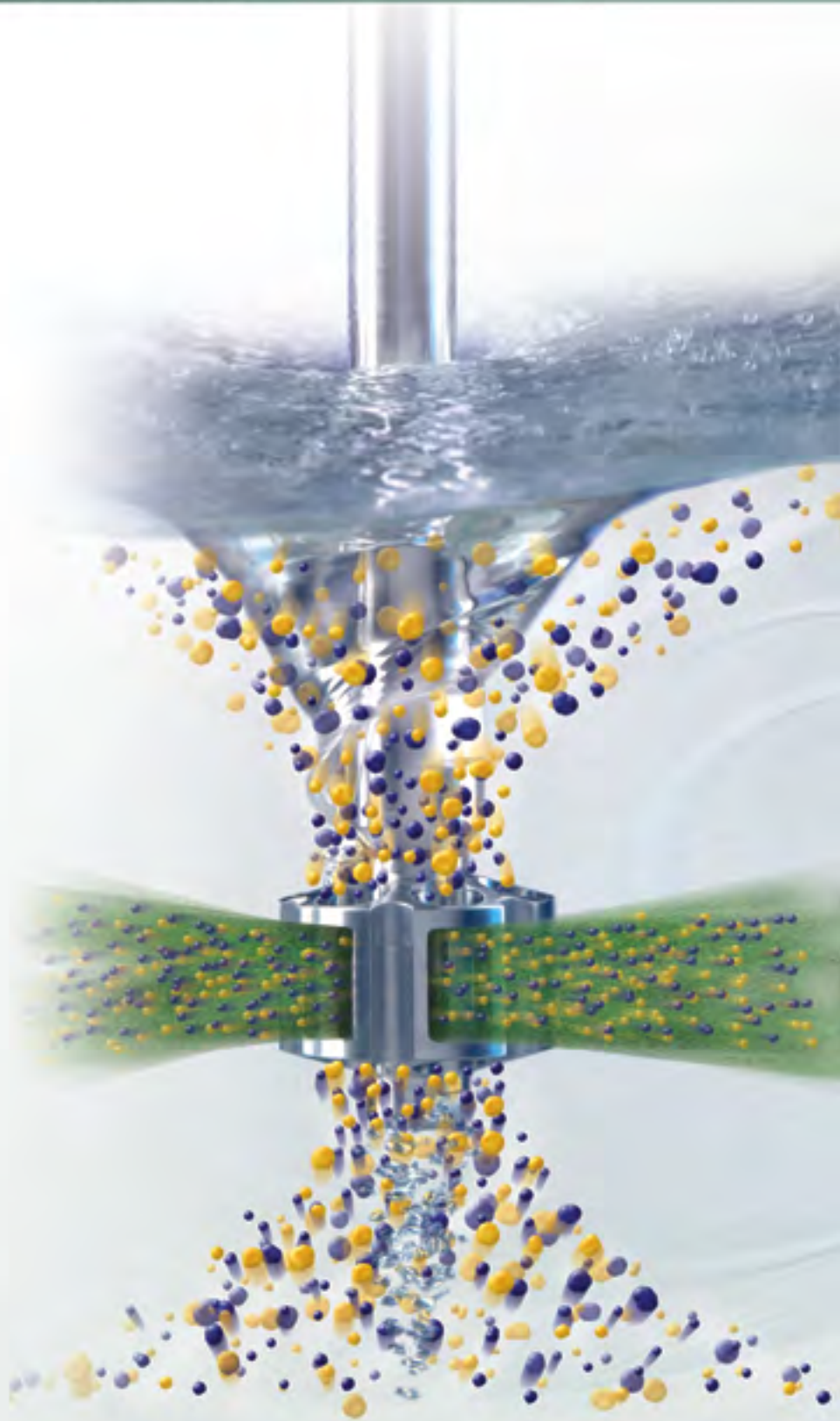

How the Ultramix works

Technical specifications

Materials of construction

All wetted parts are in 316L stainless steel. Special materials on request.

Motor specifications

TEFC, washdown duty and explosion proof motors are available as standard.

Mounting

Stainless steel flange fitting is available as standard.

Cleaning

Clean-In-Place design (CIP). Simple, easy-to-clean construction.



Stage 1

As the mixer rotates at high speed, the grooves on the outside of the dynamic mixing head project the surrounding product outwards with great force, creating an area of low pressure around the trailing edge of each groove.

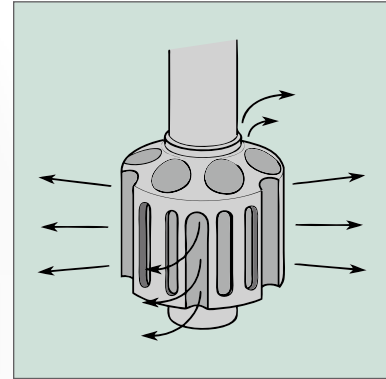

Stage 2

This draws product from within the mixing head, through the radial slots to the outside, subjecting the material to a shearing action. The grooves in the head drive the product outwards into the body of the mix at high velocity.

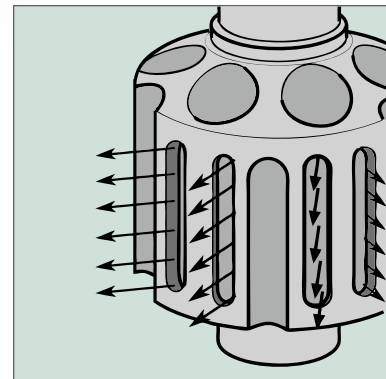

Stage 3

As material is drawn out of the slots, fresh material is sucked in through the holes in the top and bottom of the mixing head; this material is then drawn out through the slots and projected back into the mix. The pumping effect of the grooves and the shear action of the radial slots ensures rapid mixing, and develops a vigorous axial flow pattern throughout the vessel.

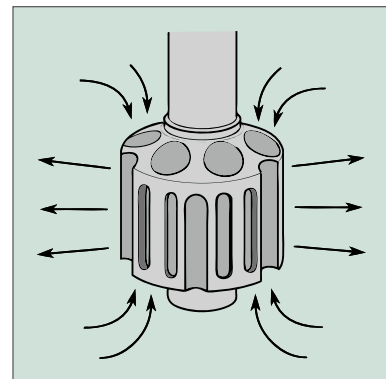

In-Line mixers

Silverson High Shear mixers are supremely efficient and rapid in operation and are capable of reducing mixing times by up to 90%.

The action of any Silverson In-Line mixer can be modified with the use of rapidly interchangeable workheads. This enables any machine to mix, emulsify, homogenize, solubilize, suspend, disperse and disintegrate solids.

- Aeration free.
- Self pumping.
- No bypassing.
- Interchangeable workheads.
- Sanitary construction.
- Easy maintenance.
- Lower power requirements.
- Eliminates agglomerates and fish eyes.
- Creates stable emulsions and suspensions.
- Reduces particle size.
- Rapidly dissolves solids.
- Accelerates reactions.



How the In-Line works

Stage 1

The high speed rotation of the rotor blades within the precision machined mixing workhead exerts a powerful suction, drawing liquid and solid materials into the rotor/stator assembly.

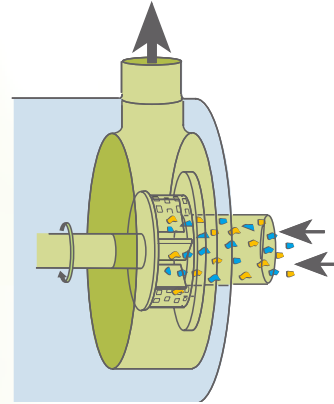

Stage 2

Centrifugal force then drives materials towards the periphery of the workhead where they are subjected to a milling action in the precision machined clearance between the ends of the rotor blades and the inner wall of the stator.

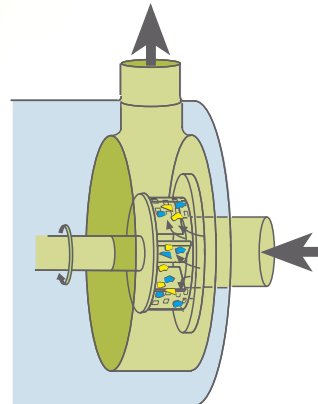

Stage 3

This is followed by intense hydraulic shear as the materials are forced, at high velocity, out through the perforations in the stator, then through the machine outlet and along the pipework. At the same time, fresh materials are continually drawn into the workhead, maintaining the mixing and pumping cycle.

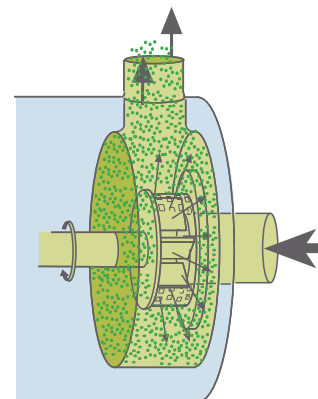

Ultra Sanitary In-Line mixers

The Silverson UHS series of Ultra Sanitary multipurpose In-Line mixers is able to perform the widest variety of applications - mixing, emulsifying, homogenizing, disintegrating and dissolving - with an efficiency, flexibility and sanitary construction unmatched by other machines.

EHEDG and **3-A TPV** (Third Party Verification) Certified and designed to comply with **FDA**, and **cGMP** guidelines, these machines are ideally suited for industries where advanced Clean-In-Place (CIP) and Sterilize-In-Place (SIP) facilities are required. The design offers further versatility with multistage rotor/stator configurations as standard options, resulting in substantially faster mixing times by reducing the number of recirculation passes required, and offering greater particle size reduction.

Features:

- Interchangeable workheads with single or multistage configurations
- Ultra Sanitary **EHEDG** Approved single mechanical shaft seals, easily converted to Ultra Sanitary **EHEDG** Approved double mechanical shaft seals
- Outlet can be configured for self-venting vertical outlet or rotated to tangential self-draining position
- Designed for Clean-In-Place (CIP) and Sterilize-In-Place (SIP) operation
- Self-pumping
- Aeration free
- Crevice-free construction
- No metal-to-metal contact
- No castings - no porosity
- All 316L stainless steel construction of wetted parts
- No manual dismantling and cleaning is required, significantly reducing maintenance, operating costs, increasing reliability and increasing productivity



Advantages

Sanitary construction

EHEDG Certified and designed to comply with **FDA, 3A TPV** (Third Party Verification) and **cGMP** guidelines, these machines are ideally suited for industries where Clean-In-Place (CIP) procedures are the norm. Not only do these include the food, pharmaceutical and cosmetic industries, but also more diverse applications where modern manufacturing techniques and maximum equipment utilization require a rapid changeover from one product to another.

Interchangeable workheads

Available to adapt the machine for varying processes. Changing from one head or screen to another is quick and simple.

Speed

Adding a Silverson In-Line mixer to an existing process can cut mixing times by up to 90% compared with conventional agitators and mixers.

No bypassing

The In-Line mixer's design makes it physically impossible for any materials - liquid or solid - to pass from the inlet to the outlet without being subjected to intense mechanical and hydraulic shear as it passes through the rotor/stator workhead. Bypassing is impossible.

Aeration free

As the In-Line mixer and associated vessel and pipework form a closed system, the mixing process is completely aeration free. This is particularly important for applications where air entrainment creates a problem.

Lower power requirements

As the mixer's energy is concentrated on processing the small volume of material inside the workhead at any given moment, power is not wasted moving large volumes of liquid, and consequently, less power is normally required than for the equivalent batch mixer. This is particularly beneficial when processing large volumes of material.



High Viscosity In-Line mixers

Silverson's new **UHS-HV** Series of In-Line Mixers are designed for processing higher viscosity products.

They offer all the advantages of the standard **UHS** range but incorporate a unique and innovative "pumping rotor" design which substantially increases the mixer's self-pumping capacity.

This high flow rate is maintained as viscosity rises, eliminating the need for an additional feed pump when processing many higher viscosity products in the food, pharmaceutical, cosmetic and chemical industries.

Features:

- Ultra Sanitary construction - based on the **UHS** mixer range
- Self-pumping
- Aeration free
- No bypassing
- Interchangeable workheads
- Vertical or self-draining tangential outlet
- Designed for Cleaning-In-Place

Typical Applications

High Viscosity In-Line mixers are ideal for applications in the Food, Pharmaceutical, Cosmetic and Chemical industries, including preparation of Gels, Creams, Gums & Thickeners, etc.



General duty In-Line mixers

Silverson offers a range of In-Line mixers suitable for hazardous and aggressive chemical service.

These units are of robust and simple construction, which ensures that maintenance is easy and downtime minimal.

With some of the highest rotor tip speeds and shear rates in the industry, production times can be cut by up to 90%, reducing mechanical wear and maintenance requirements, while offering better particle size reduction, emulsification, rapid solubilization and dispersion.

Optional features

- Jacketed units for temperature sensitive products.
- Non-standard materials of construction such as hastelloy, titanium and hardened steels for processing highly abrasive or corrosive products.
- High capacity units with self-pumping capacities from 5 up to 50,000 gallons per hour.

Typical Applications

Bitumens, Edible oil refining, Drilling muds, Adhesives, Luboils, Pigment dispersions, Titanium dioxide, etc.



Technical specifications

Materials of construction

Product contact parts in 316L Stainless Steel. Special materials on request.

Motors

TEFC (Totally Enclosed Fan Cooled) washdown duty and NEMA explosion proof rated motors are available as standard. Inverter rated, stainless steel and other motors are available as optional extras.

Operating pressures

All Sanitary Multipurpose models are designed for operation on pressures of up to 150 psi (10 bar). General Duty models 100 psi (7 bar). Higher pressure units are available on request.

Inlet and outlet connections

Tri-Clamp or ASA 150 flanges are available as standard. ISS, DIN, RJT and SMS are available on request.

Interchangeable workheads

Single stage rotor/stator configurations as standard. For those applications which require greater shear, interchangeable multistage configurations can be used.



General purpose disintegrating head



General purpose disintegrating head, multistage inner and outer



Slotted disintegrating head



Slotted disintegrating head, multistage inner and outer



Square hole high shear screen™



Combined configuration: inner general purpose with outer slotted disintegrating head



Emulsor screen



Combined configuration: inner slotted with outer square hole high shear screen™

How to use In-Line mixers

Recirculation method

This is the most common way of using an In-Line mixer, providing a higher degree of homogenization and particle size reduction. Here product is drawn from the bottom of the vessel, processed through the high shear rotor/stator workhead and passed back into the top of the vessel.

In small vessels this will ensure adequate in-tank movement but in larger vessels an auxiliary in-tank mixer or agitator will be required.

Additional fluid ingredients can be fed into the workhead and uniformly mixed before entering the vessel.

Where quality assurance (QA) demands a set number of passes through the rotor/stator workhead, product can be passed back and forth between two separate vessels.

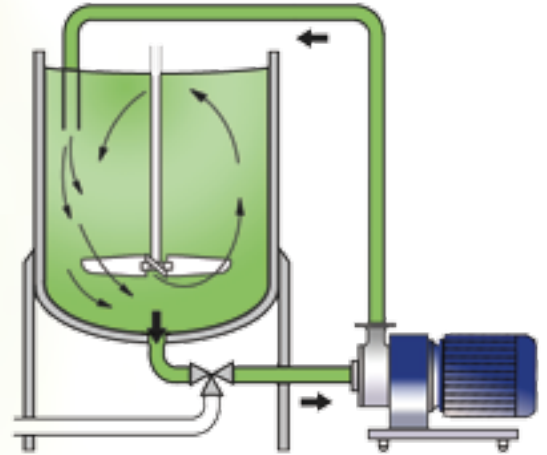

Single pass method

There are basically three types of operations for which single pass processing can be used.

Continuous blending

Ingredients are metered into the mixer or a manifold just prior to the rotor/stator workhead. This ensures that products that react together are mixed immediately on contact. This method is ideal for continuous liquid/liquid blending and for products where aeration must be avoided, i.e. detergents.

Series processing

In cases where a higher degree of homogenization or comminution is required than

can be obtained by a single pass through the In-Line mixer, it is possible to achieve the required results by using two or more machines in series.

Premix method

The ingredients are coarsely premixed in a holding vessel with a Silverson Batch mixer, Ultramix or a simple agitator. A single pass through the In-Line mixer will then ensure an agglomerate-free homogeneous product. All the product must pass through the In-Line mixer's rotor/stator workhead as bypassing is impossible.

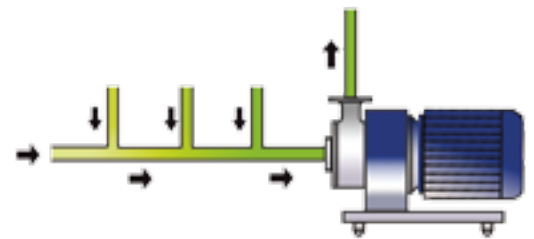

Silverson powder/liquid mixers

Silverson has over 60 years' experience in powder/liquid mixing and offers mixers for a wide range of materials and batch sizes.

The new **Flashmix** is a modular unit that provides a simple, effective and sanitary means of incorporating powders into liquids, even at higher viscosities and at elevated temperatures.

The **Flashblend** is a semi-automated system designed for bulk powder dispersion and ultra-sanitary applications.

The Silverson approach to powder/liquid mixing offers a number of advantages:

Repeatability

Most problems that occur when adding powders into liquids are typically due to operator error - for example adding powders too quickly. With a Silverson mixer the machine dictates the powder addition rate, so repeatability is assured and a consistent homogeneous product will be produced time after time.

Speed

Powder incorporation rates of up to 500 lbs/min substantially reduce process times compared with conventional methods of powder dispersion.

Minimum aeration

Careful attention to design and the speed of powder incorporation ensures that aeration is kept to an absolute minimum. Ideal even for products that tend to foam or aerate easily.

Improved vessel hygiene

Powder is fully dispersed before it enters the mixing vessel, preventing the build-up of partially hydrated powder on the vessel wall that can be encountered when using an in-tank agitator or mixer to disperse powders.





Typical powder dispersion applications

Food industry:

Gum dispersions: Xanthan, Guar, Acacia, etc.

Sugar solutions

Ice cream: Milk powder, Sugar, Cocoa, Stabilizers, etc.

Yogurt: Milk powder, Sugar, Pectin, Gelatin, etc.

Baby milk: Skimmed milk powder, Lactose, Soya protein, Maltodextrin, Fat

Flavored milk drinks: Milk powder, Cocoa, Chocolate crumb, etc.

Soups: Starch, Milk powder, Powdered cream, etc.

Sauces and dressings: Starch, Xanthan gum, Guar gum, Alginates, CMCs, etc.

Flavorings: Acacia gum

Low fat spreads: Caseinates, Gelatine, Starch, etc.

Standardization of milk: Milk powder, Lactose

Sweetened condensed milk: Sugar, Milk powder

Jams and preserves: Pectin solutions

Pet foods: Starch, Guar gum, Xanthan gum, Alginates

Pharmaceuticals

Tablet coatings: Polymer dispersions

Contact lens solutions: Thickening agents, Salts, etc.

Nutrient broths and media: Yeast extracts, Proteins, Sugars, Minerals, etc.

Syrups and linctus: Sugar, Thickening Agents, Active ingredients

Oral suspensions: Thickening agents, Active ingredients

Cosmetics and toiletries:

Carbopol dispersions

Hair gels: Carbopol

Hairsprays and mousses: Resin into alcohol

Shampoos: Sodium Laureth Sulphate (SLES) into water

Deodorants: CMC, Active ingredients

Dental adhesives: Polymer dispersions

Beverage and brewing:

Soft drinks: CMC, Pectin, etc.

Beer: Head retaining agents, Finings

Cream liqueurs: Caseinates, Sugar

Chemical and petrochemical:

Fumed silicas into oils, Resins and water

Specialty chemicals: Crystalline powders into solvents

Drilling muds: Continuous production of Bentonite muds

Oil Blending: Incorporation of lime, etc.

Agrochemicals:

Suspending agents: Bentonite, Xanthan gum, etc.

Dispersion of active ingredients

Flashmix powder/liquid mixing system

The new Silverson Flashmix takes a revolutionary approach to powder/liquid mixing. Unlike many powder/liquid mixers, which use vacuum to pull in powders, the Flashmix literally forces powder into the liquid stream. This not only allows it to disperse and hydrate large

volumes of powders, it means it can be used at higher temperatures and with higher viscosity mixes - offering the advantages of high shear mixing to a wide range of applications that were previously not possible.

Advantages

- Fast powder incorporation rates of up to 500 lbs/min.
- Agglomerate-free, consistent product, time after time.
- Suitable for operation at higher temperature.
- Suitable for higher concentrations of gums and thickeners.
- Minimum aeration.
- Sanitary - the Flashmix is based on an EHEDG and 3-A Certified sanitary mixer.
- Modular construction with a range of options to suit requirements.
- Low power requirement; no additional pump required.
- Low level, ergonomic design.
- Simple - the Flashmix is easy to install, easy to operate and easy to clean.

PATENT PENDING



Flashmix operating principle

The Silverson Flashmix offers a unique method of incorporating powders into liquids, producing an agglomerate-free and homogeneous product:

Stage 1

The self-pumping Flashmix recirculates liquid from the process vessel through the rotor/stator workhead at high velocity.

Stage 2

The powder feed valve is opened, and the high pumping action of the mixer forces the powder into the liquid stream.

Stage 3

The powder and liquid components are introduced straight into the high shear zone of the mixer, and are instantaneously combined as they are subjected to intense mechanical and hydraulic shear. The resultant mix is pumped back into the vessel.

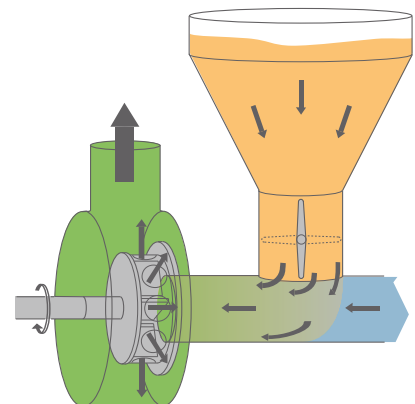
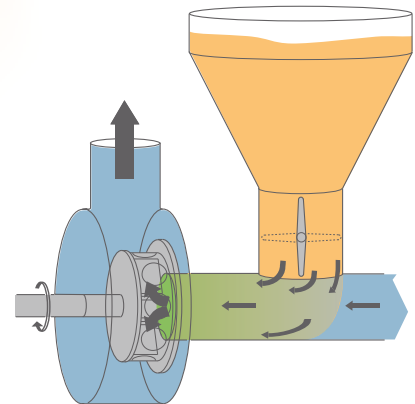
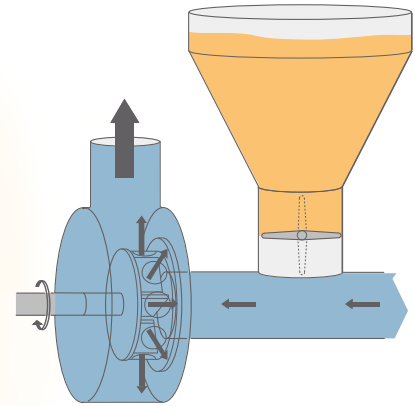

Flashmix operation and performance

Operation

The Flashmix is designed for use in a recirculation system as shown. Powder is rapidly incorporated by the self-pumping Flashmix, and a brief period of recirculation results in an agglomerate-free, homogeneous dispersion.

An auxiliary in-tank mixer or agitator will normally be required to maintain uniformity in the process vessel.

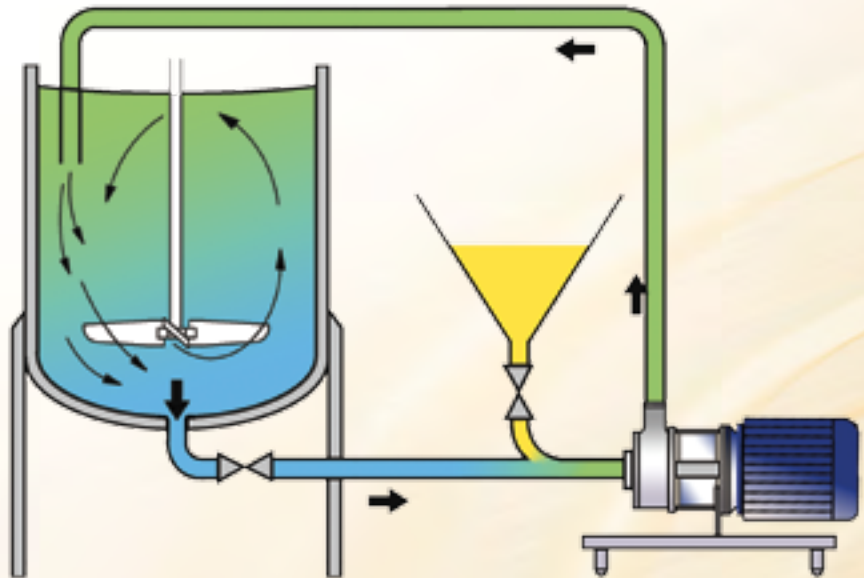

Performance

Typical liquid flow and powder incorporation rates are given in the table.

Model	Liquid flow rate (gallons/min)	Typical powder incorporation rate (lbs/min)		
		Gums & thickeners	Milk proteins	Sugars
FMX25	120	25	90	40
FMX50	230	48	255	80
FMX75	375	165	460	380

Figures given are based on repeated practical testing and represent typical values for guidance only.

Technical specifications and options

Materials of Construction

All product contact parts are in 316L stainless steel. The chassis is constructed from 304 stainless steel.

Motor specifications

TEFV (Totally Enclosed Fan Ventilated) motors are available as standard. Other types of motor and enclosures are available as options.

Inlet and outlet connections

Tri-clamp fittings are standard. Other fittings on request.

Sealing

Hygienic single mechanical shaft seals are standard. Double mechanical shaft seals available.

Valves

Manual butterfly valves are standard.

Cleaning

Designed for Cleaning-In-Place (CIP).

Hopper

Various hoppers are available according to model and application, including profiled hopper for minimal aeration.

Sack Table

A stainless steel sack table is available for FMX25 and FMX50.

Automation

As an optional extra the Flashmix can be supplied with pneumatic valves coupled to a powder sensor for semi-automatic processes.



FMX25 with 1.4 cu ft hopper and manual valve



FMX50 with 3.5 cu ft hopper and manual valve



FMX75 with 10.6 cu ft hopper, pneumatic valve and powder sensor

Flashblend powder/liquid mixing system

The Silverson Flashblend is designed to incorporate large volumes of powders on a continuous and semi-continuous basis, at rates of up to 500 lbs/min. The semi-automated system can be specified for ultra-sanitary applications and custom built to suit clients' specific requirements. There are over 500 Flashblend systems in use worldwide throughout all sectors of the process industry.

Advantages

- Suitable for large scale production.
- Can be incorporated into automated systems.
- Fully sterilizable units available.
- Can be customized to suit client requirements.
- Agglomerate-free product.
- Repeatability.
- Speed.
- Minimum aeration.
- Improved vessel hygiene.



Flashblend operating sequence

Operation

Liquid is forced through the system by the pump (1). The liquid flow through the venturi assembly (2) creates a vacuum, boosted by the pumping action of the Silverson In-Line mixer (3). When powder is present in the hopper (4), the valve (5) can be opened and powder is drawn down into the venturi by the vacuum.

The powder/liquid mix immediately passes into the high shear rotor/stator assembly of the Silverson In-Line mixer, ensuring a finely dispersed and agglomerate-free mixture. The resultant product is passed back to the process vessel by the pumping action of the machine.

Once the hopper is empty, the sensor (6) will automatically shut

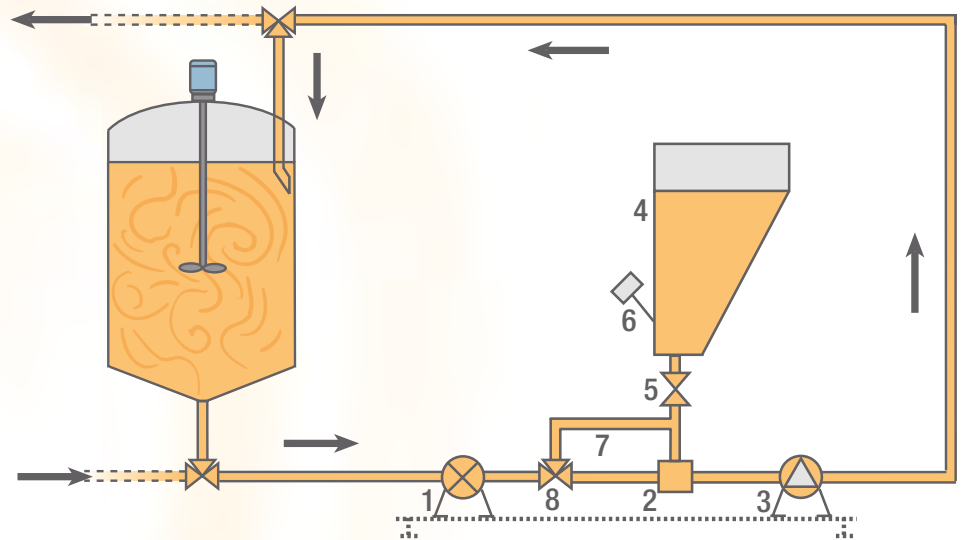

the valve, minimizing aeration. When the powder sensor closes the powder feed valve, product flow can be diverted round a bypass line (7) by the diverter valve (8).

The high flowrate in this mode ensures a scouring action of the

venturi housing, keeping the area free of any buildup of partially hydrated powder.

The bypass position is also used for Cleaning-In-Place (CIP), ensuring that the venturi area is cleaned to as high a standard as normal sanitary piping.

Technical Specifications

Materials of Construction

All product contact parts are in 316L stainless steel. The chassis is constructed from 304 stainless steel.

Sealing

Sanitary single mechanical shaft sealing is standard. Double mechanical shaft seals are available.

Motor specifications

TEFC, washdown duty and explosion proof motors are available as standard. Inverter rated, stainless steel and other motors are available as optional extras.

ATEX

Units suitable for use in Zone 22 areas are available.

Inlet and outlet connections

2" Tri-clamp fitting as standard. Other fittings on request.

Cleaning

Designed for Cleaning-In-Place (CIP). Sterilize-In-Place (SIP) and Cleanroom standards are available.

Bottom Entry mixers

Silverson's sanitary series of High Shear Bottom Entry mixers are designed to fit into the bottom or side of a mixing vessel. These high shear mixers are typically used in conjunction with a slow speed anchor stirrer or scraper unit for high viscosity products. The Silverson Bottom Entry mixer gives high shear homogenization, while the stirrer/scraper distributes the homogenized output uniformly through the vessel. This is ideal for high viscosity cosmetic, pharmaceutical and food products.

Bottom Entry mixers can also be used by themselves on low viscosity products and to wet out powders.

Silverson Bottom Entry mixers offer full compliance with USDA and cGMP requirements.

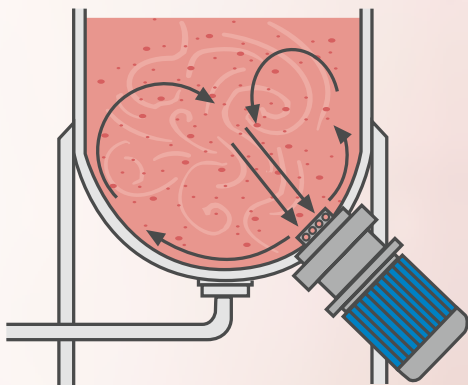

Technical specifications

Materials of construction

All wetted parts are in 316L stainless steel. Special materials on request. Electropolished finish is available as an optional extra.

Motor specifications

TEFC, washdown duty and explosion proof motors are available as standard. Inverter rated, stainless steel and other motors are available as optional extras. Electrical switchgear or wiring is not supplied.

Mounting

Stainless steel flange fitting is available as standard. Clamp-on fitting is optional for smaller machines.

Sealing

Single mechanical shaft sealing: A single carbon/ceramic mechanical shaft seal with viton elastomers is standard. Other face materials and elastomers are available as optional extras.

Double mechanical shaft sealing: These are required when processing products that are abrasive, sticky or viscous or when the system is under vacuum.

Sealant flushing systems can be supplied as optional extras.

Cleaning

Clean-In-Place (CIP) design. Simple, easy-to-clean construction.

Operating pressures

All standard models are designed for operation on pressures not in excess of 40 psi (2.8 bar). High-pressure units are available upon request.

Ultra sanitary model available with features including:

- Crevice-free construction.
- Sanitary metal bellows shaft seal.
- Electropolished finish.



General purpose disintegrating head



Slotted disintegrating head



Square hole high shear screen™



Emulsor screen



Disintegrator 2500

If you thought it couldn't be done think again. Silverson's mighty Disintegrator mixing system will disintegrate, solubilize or disperse the largest of solids - up to 40" (1000mm) across - in a single operation and in times you wouldn't believe!

The D2500 incorporates a powerful and unique Silverson mixer located in the bottom of a custom-built vessel. The mixer exerts a massive suction downwards from the surface of the liquid, pulling down even the most buoyant of solids, no

matter what the size. These solids are literally ripped apart and dispersed throughout the mix, and with the refinement of a Silverson In-Line mixer, included in the system, are totally solubilized or suspended.



How the D2500 works

The D2500 is a self-contained, high-powered unit consisting of a specially designed Silverson high shear rotor/stator disintegrating workhead set into a custom-built vessel coupled with a Silverson High Shear In-Line mixer.

Stage 1

The unit is charged with liquid and started. Large solids are fed into the vessel and drawn down into the workhead, which will rapidly shear lumps and slices off the edges and corners. These will be drawn into the interior of the workhead, driven by centrifugal force to the periphery and further sheared by the rotor tips against the edges of the stator as they are expelled radially from the head.

Stage 2

Rapid fragmentation of the large solids continues until all the particles are small enough to be drawn into the workhead for further disintegration. Materials are discharged horizontally from the workhead and forced up the vessel's walls, drawn into the center vortex and repeatedly through the workhead for final disintegration. This cycle continues until all solids are reduced to granular size.

Stage 3

Once the solids are down to granular size, the self-pumping Silverson In-Line mixer is started. The product is drawn from the bottom of the vessel, processed through the In-Line mixer's high shear rotor/stator workhead and passed back into the top of the vessel, ensuring complete solution or suspension.

Stage 4

Samples may be taken off at any time during the process. When inspection shows that all solids are completely dissolved or suspended, any additives or final additions of solvent to standardize the product may be introduced either into the vessel or into the In-Line mixer loop.

As soon as the product passes inspection and quality control, the vessel may be emptied either through the Silverson In-Line mixer or a separate self-draining outlet.

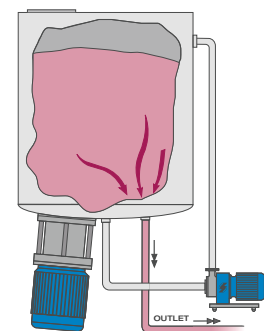
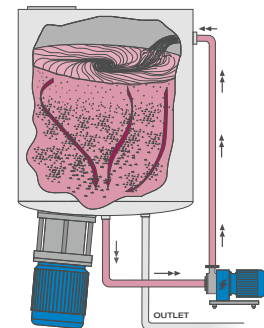
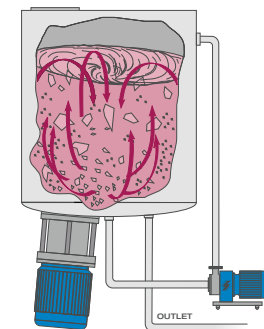
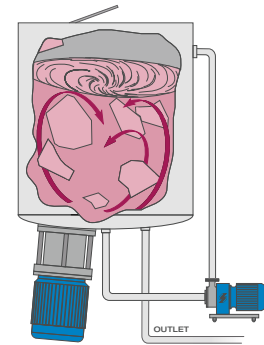

Advantages

Size and shape of product is inconsequential. The Disintegrator 2500 can take odd shapes and the largest sized polymer bales commercially produced.

- No need for pre-grinding, slicing or cutting of large solids. All solids are dissolved in one vessel.
- Elimination of additional equipment such as grinders or choppers reduces maintenance costs and dust emissions.
- Puts products into complete solution or suspension without leaving undesired particles on vessel walls.
- Can handle poly-wrapped bales without prior removal of wrapper, eliminating the need for cutting and excess waste.

Typical Applications

- Rapid solution of rubbers and polymers into lubricating oils, solvents and bitumen for the production of VM luboils, adhesives and polymer modified bitumen for road surfacing
- Dispersion of filter cakes.
- Disintegration of solid blocks of cheese, butter, compressed raisins & dried fruit, oleoresins and frozen meat.
- Disintegration and dispersion of animal and vegetable matter.
- Wet crumbing of waste rubber.
- Disintegration of solid gums, resins and varnishes.
- Recovery of waste confectionery.



Further information

Silverson.com is a multilingual hub for information about high shear mixing and Silverson precision-engineered mixers.

The mobile-friendly site offers product and process specs, plus videos demonstrating the effectiveness of high shear mixing. Site visitors can also find application reports, scale-up material, get mixing tips and ask Silverson experts mixing questions.

Mixing info can be accessed quickly and in 15 languages—Arabic, Chinese, English (U.K./U.S.), French, German, Italian, Japanese, Korean, Polish, Portuguese, Russian, Spanish, Thai and Turkish.

www.silverson.com



United States

Silverson Machines, Inc.
355 Chestnut Street
East Longmeadow, MA 01028
Tel: (413) 525-4825
Fax: (413) 525-5804
Email: sales@silverson.com

United Kingdom Corporate Headquarters

Silverson Machines Ltd.
Waterside, Chesham
Buckinghamshire HP5 1PQ
England
Tel: +44 (0) 1494 786331
Fax: +44 (0) 1494 791452
Email: sales@silverson.co.uk

France

Silverson France
12 Boulevard Louise Michel
91030 EVRY CEDEX
France
Tel: +33 (0) 1 60 77 91 92
Fax: +33 (0) 1 60 77 81 88
Email: info@silverson.fr

Japan

Silverson Nippon Limited
Onohara Higashi 4-22-3
Mino 562-0031
Osaka-Japan
Tel: +81-72-734-8003
Fax: +81-72-734-8004
Email: sales@silverson.co.jp

Silverson can be found on the World Wide Web at www.silverson.com

Silverson® is a registered trademark of Silverson Machines.
Square Hole High Shear Screen™ is a trademark of Silverson Machines.
Patent Pending.